



TMLINE  
Scandinavian Living

MMS Multi Media Storage





02

## MMS Multi Media Storage:

MMS Introduction/ Indledning	03-03
MMS Storage and function / Opbevaring og funktion	04-04
MMS in white lacquer / MMS i hvid lak	05-09
MMS in black lacquer oak structure / MMS i sort lak eg struktur	10-14
MMS Basic module survey / Grundlæggende moduloversigt	15-15

## Introduction

MMS is a modular system designed for the storage of all your multi-media equipment. It is a stylish and practical way of displaying TVs, hi-fi units and accessories, ensuring that cables are hidden and your room looks perfectly organised and clutter-free. The modules can be wall-mounted or floor-standing and can also be stacked on top of each other. This flexibility means that MMS can be selected to ideally suit your living space and individual multi-media requirements. MMS reflects true Scandinavian design traditions, by embracing simplicity, aesthetic beauty and functionality. This simplicity is evident in the handle-free units and the concealment of drawers and doors, which create smooth, elegant lines. Each of the modules is designed for optimum storage of modern hi-fi units, with optional cable entries and ventilation holes tailored to your exact requirements. Additional information about measurements, weight load and technical facts can be found in the accompanying price list.

## Indledning

MMS er et modulært system, som er udviklet til primært at opbevare hifi enheder og hifi tilbehør, således at afspillere og modtagere, Dvd'er og Cd'er, kabler og ledninger ikke forstyrrer i rummet. Modulerne kan væghænges eller stå på gulvet, og gulvmodulerne kan stå oven på hinanden. Dermed kan opstillinger tilpasses det enkelte rums fysiske rammer og samtidig få det udtryk, der passer til dine ønsker. MMS er skandinavisk design, som tager udgangspunkt i skandinaviske design traditioner, og specielt tager designet fat i det enkle frem for det komplicerede. Bemærk bl.a. at skuffer og låger ligger indvendigt i modulerne, som dermed skaber en ramme om møblet, og at alle enheder er grebsløse for at støtte det enkle udtryk. MMS sikrer optimal opbevaring og styring af kabelføring, ved at skuffer og rum er tilpasset nutidens hifi enheder, og at kabeludgangshuller og ventilationshuller er valgfri og laves individuelt. Yderligere oplysninger omkring mål, vægtbelastninger og tekniske data findes i den tilhørende prisliste.



## Function and storage

01: The fittings for wall mounting can also be adjusted from the exterior after the module has been wall mounted. The back panel is in 2 parts allowing for the cables to be pulled backwards

01: Beslaget til vægmontage kan også justeres ude fra, efter at modulet er monteret på væggen. Bemærk at bagklædning er to-delt, således at kabler kan trækkes bagud

02: Optional cable entries and ventilation holes, here shown with a cable entry in polished steel.

02: Valgfri kabeludgang og ventilations-udgange, her vist med kabelgennemføring i poleret stål

03: Back panels are in 2 parts ensuring that cables can be pulled backwards. As accessories we offer back panels in the same finish that entirely hide the cables when you open the unit. There are 18mm between the back panel and the back of the module for storage of cables.

03: Bagklædninger er to-delte, som sikrer, at du kan føre dine kabler bagud. Som tilbehør tilbyder vi bagklædninger i overflade finish, som helt skjuler kablerne, når du åbner. Der er 18mm mellem bagklædning og modulets bagkant til opbevaring af kabler

04: Push, drawers and doors open and close.

04: Push, skuffer og låger åbnes og lukkes



04

05: The wall tower stores DVDs and CDs, etc. and glass shelves have optional placing.

05: Vægtårnet opbevarer Dvd'er, Cd'er m.m. og glasshylder har valgfri placering

06 Spacious drawers with SYNCRON and full extension, store up to 204 CDs, or 160 DVDs in a 90cm drawer.

06 Rummelige skuffer med SYNCRON og fuldt udtræk, opbevarer op til 204 Cd'er eller 160 Dvd'er per 90cm skuffe

07: Behind the touch catch door with damper you can store hi-fi units that can be placed side by side or be stacked on top of each other.

07: Bag vippelågen med dæmper er der plads til hifi enheder, som kan stilles side by side, eller sættes oven på hinanden

08: The Cube module has 2 movable shelves for optimum storage.

08: Cube modulet har 2 flytbare hylder, som gør, at opbevaring kan optimeres





White lacquered, floor module with drawer and touch catch door in glass (h\*w\*d) 46.7\*177.7\*45cm / asymmetric module 46.7\*90\*35cm / floor module 24.6\*120\*45cm

Hvidlakeret, gulvmodul med skuffe og glas vippelåge (h\*b\*d) 46,7\*177,7\*45cm / asymmetrisk modul 46,7\*90\*35cm / gulvmodul 24,6\*120\*45cm



White lacquered, floor module with drawer (h\*w\*d)  
24.6\*120\*45cm / asymmetric module with touch catch door  
46.7\*90\*35cm

Hvidlakeret, gulvmodul med skuffe (h\*b\*d) 24,6\*120\*45cm /  
asymmetrisk modul med vippeåge 46,7\*90\*35cm



White lacquered, wall tower (h\*w\*d) 177.7\*26.8\*35cm /  
wall module with drawer and touch catch door with glass  
48.9\*177.7\*45cm

Hvidlakeret, vægtårn (h\*b\*d) 177,7\*26,8\*35cm / vægmodul  
med skuffe og glas vippeåge 48,9\*177,7\*45cm





08

White lacquered, floor module with drawer and touch catch door in glass (h\*w\*d) 46.7\*177.7\*45cm

Hvidlakeret, gulvmodul med skuffe og glas vippelåge (h\*b\*d)  
46,7\*177,7\*45cm



White lacquered, wall module with touch catch door (h\*w\*d)  
26.8\*90\*45cm

Hvidlakeret, vægmodul med vippelåge (h\*b\*d) 26,8\*90\*45cm



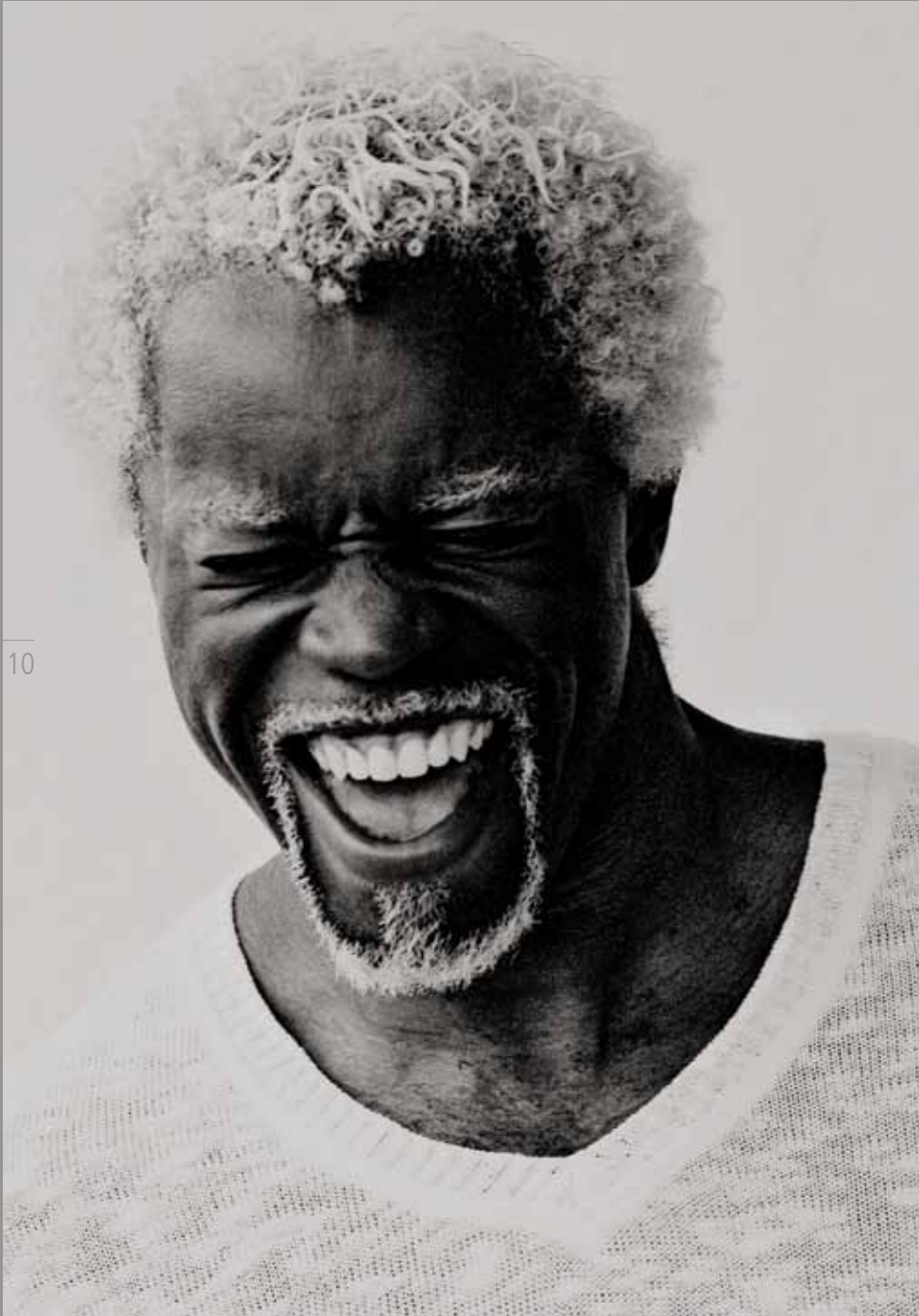



Black lacquered oak structure, floor module with drawer and touch catch door in glass (h\*w\*d)  
46.7\*120.7\*45cm / asymmetric module with touch catch door 46.7\*90\*35cm / floor module 24.6\*120\*45cm  
/ cube module 70\*70\*35cm

Sortlakeret eg struktur, gulvmodul med skuffe og glas vippelåge, (h\*b\*d) 46,7\*120,7\*45cm / asymmetrisk  
modul med vippelåge 46,7\*90\*35cm / gulvmodul 24,6\*120\*45cm / cube modul 70\*70\*35cm



Black lacquered oak structure, 3 wall towers (h\*w\*d) 177.7\*26.8\*35cm / floor module with drawer and touch catch door in glass, (h\*w\*d) 46.7\*120.7\*45cm / asymmetric module with touch catch door 46.7\*90\*35cm / floor module with drawer 24.6\*120\*45cm / cube module 70\*70\*35cm

Sortlakeret eg struktur, 3 vægtårne (h\*b\*d) 177,7\*26,8\*35cm / gulvmodul med skuffe og glas vippelåge, (h\*b\*d) 46,7\*120,7\*45cm / asymmetrisk modul med vippelåge 46,7\*90\*35cm / gulvmodul med skuffe 24,6\*120\*45cm / cube modul 70\*70\*35cm



Orange/black lacquered oak structure, 2 wall towers (h\*w\*d) 177.7\*26.8\*35cm / wall module with drawer and touch catch door in glass 46.7\*120\*45cm

Orange/sortlakeret eg struktur, 2 vægtårne (h\*b\*d) 177,7\*26,8\*35cm / vægmodul med skuffe og glas vippelåge 46,7\*120\*45cm





Black lacquered, floor module with drawer and touch catch door in glass (h\*w\*d) 46.7\*120.7\*45cm / asymmetric module with touch catch door 46.7\*90\*35cm / floor module with drawer 24.6\*120\*45cm

Sortlakeret, gulvmodul med skuffe og glas vippelåge (h\*b\*d) 46,7\*120,7\*45cm / asymmetrisk modul med vippelåge 46,7\*90\*35cm / gulvmodul med skuffe 24,6\*120\*45cm

FLOOR MODULES / GULVMODULER

h\*w\*d      h\*b\*d



24,6\*90\*45

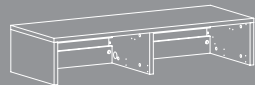

24,6\*120\*45

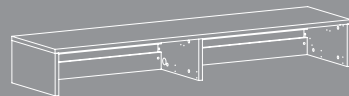

24,6\*177,7\*45



46,7\*90\*45

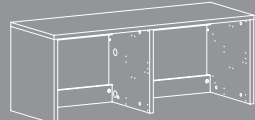

46,7\*120\*45



46,7\*177,7\*45

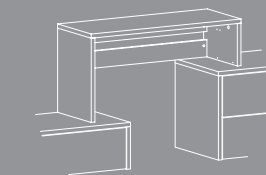
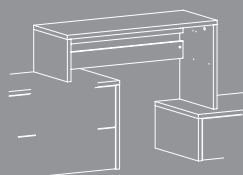

46,7\*9\*35

WALL MODULES / VÆGMODULER



26,8\*90\*35



26,8\*120\*35

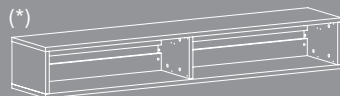

26,8\*177,7\*35

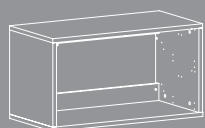

48,9\*90\*45

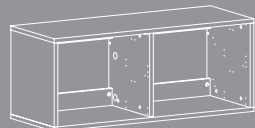

48,9\*120\*45

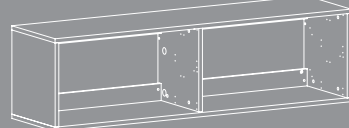

48,9\*177,7\*45



177,7\*26,8\*35



120\*26,8\*35



90\*26,8\*35



70\*70\*35

(\* Depth/dybde 35cm, not for drawers / ikke for skuffer

DRAWERS & TOUCH CATCH DOORS / SKUFFER & VIPPELÅGER

h\*w\*d

h\*b\*d



21,8\*85\*32,4



21,8\*155\*32,4

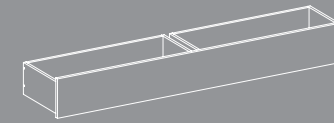

21,8\*172,6\*32,4



22\*84,9\*31



22\*114,9\*31



22\*172,6\*31



22\*84,9\*41



22\*114,9\*41



22\*172,6\*41

ALL MODULES CAN BE PURCHASED WITH OR WITHOUT HOLES FOR CABLE MANAGEMENT /  
ALLE MODULER KAN KØBES MED ELLER UDEN HULLER FOR KABELGENNEMFØRING

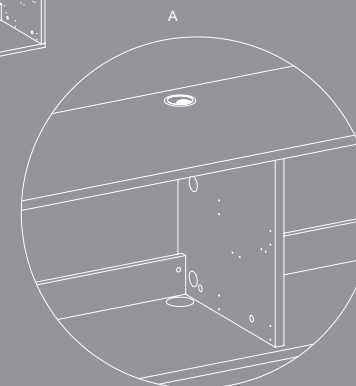
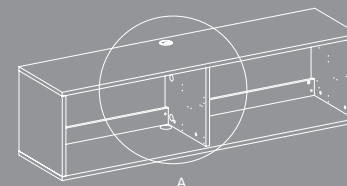

## Credits

Catalogue idea and layout by:  
Jens Vang

Product design by:  
Anders Nørgaard

Technical design and development by:  
TM Line A/S

Photography by:  
Danica Reklame Foto

Graphic production by:  
Jens Vang

Reproduction by:  
Jens Vang

Print by:  
Reklame Tryk Herning



TM Line A/S  
Eriksvej 22  
DK-8960 Randers SØ  
Tel.: +45 86420399  
Fax: +45 86408570  
Email: [mail@tmline.dk](mailto:mail@tmline.dk)  
[WWW.tmline.dk](http://WWW.tmline.dk)